

# Ogi Drive technical specification



**.mdd**

**.mdd has a leading position among manufacturers of office furniture with many awards that prove quality and continuously increase demand for its products.**

The realities of today's market require constant quality improvement at all levels of modern organization. This applies in particular to customer service, marketing, quality of products and also to quality of processes within the company. Partnership relations among employees and with business partners form a base of economic growth and success of the company.

Constant investments in innovative machinery park, optimization of management systems and an expansion of production halls allow to minimize the lead times for the product of the highest quality.

**More than twenty years of experience in office furniture industry come with reference from a long list of companies and institutions to show their appreciation for an efficient and comprehensive service.**

**.mdd is highly aware of the environment.**

Being located in the forest region with lake by its side, .mdd takes the nature seriously and invests constantly in a modern and energy-efficient solutions to preserve the local life. Company puts emphasis on waste segregation and recycling. .mdd has been awarded for the exceptional care and involvement in waste disposal. All materials used are environmentally friendly and enjoy a high 95 % rate of being recycled.



**General informations:**

**Warranty:**

.mdd products – **5 years**.  
Electrical components and fabric – **2 years**.

**Certificate – MFC:**



**Assembly:**

product delivered in separate elements

**Packing:**

cardboard

**Boards density:**

12 mm – 690 – 750 kg/m<sup>3</sup>  
18 mm – 650 – 690 kg/m<sup>3</sup>  
28 mm – 610 – 630 kg/m<sup>3</sup>  
36 mm – 610 – 630 kg/m<sup>3</sup>

**Compliant with standards:**

DIN EN 13849-1:2007, Performance Level B;  
RoSH 2011/65/UE;  
LVD; EU Directive 2006/95/EC;  
EMC according to EU Directive 2004/108/EC;  
PN-EN 55014-1:2017-06;  
PN-EN 55014-2:2015-06;  
PN-EN 60204-1:2010P;  
PN-EN 61000-1-2:2016-11;  
PN-EN 61000-6-3:2008/A1:2012;  
PN-EN 60335-1:2012;  
PN-EN-ISO-12100\_2012P

**Material composition \*:**

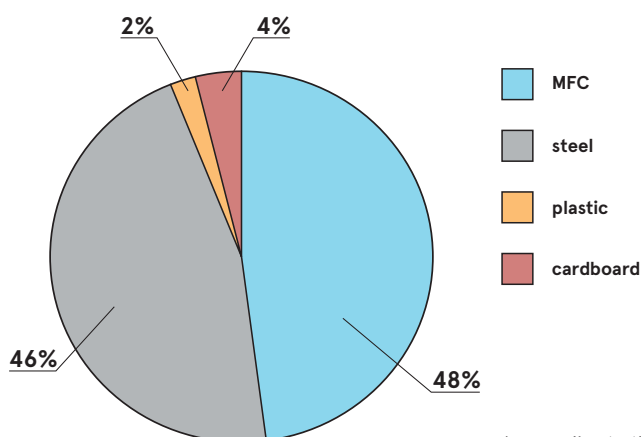

\* according to the EPD document

**Recyclability \*\***

Recycling: 50% - Downcycling: 50%

**Recycled content**

43%

**Co2 carbon footprint**

56,5 kg

\*\* average values for a representative of the group; values may vary for other products

## Ogi desk worktops

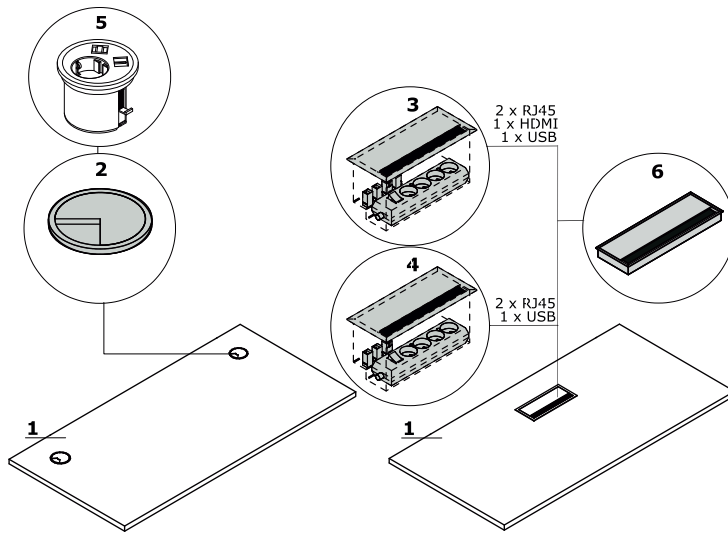

1. Worktop - MFC 28 mm, ABS edge

**OPTIONS WITH EXTRA CHARGE:**

2. Grommet - 2 pcs, Ø 80 mm

3. Mediabox M04H - 2 x RJ45 (class E, cat. 6); + 1 x USB + 1 x HDMI + 4 x 230V

4. Mediabox M04 - 2 x RJ45 (class E, cat. 6); + 1 x USB + 4 x 230V

5. Mediabox M07 - 1 x 230V + 1 x USB charger + 1 x RJ45, colour: black, white, mounted instead of the existing grommet Ø80 mm (Pk80)

6. Top access M05

7. Cable way - the width of the opening is proportional to the width of the worktop

8. Mediabox M07 + cable grommets

9. Cable way + cable grommets - desks, bench desks

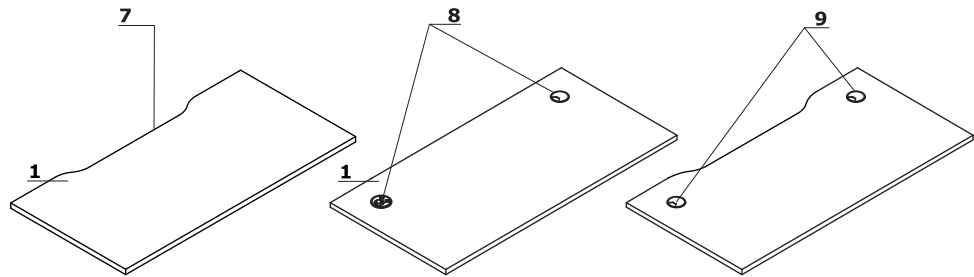

## Frame

1. Ogi Drive with electric height adjustment - in the range of 650-1300 mm, metal, powder coated, 3 profiles 50 × 50 mm, 55 × 55 mm and 60 × 60 mm

2. Ogi Drive with electric height adjustment - in the range of 700-1200 mm, metal, powder coated, 2 profiles 55 × 55 mm and 60 × 60 mm

3. **OPTION WITH EXTRA CHARGE** - Pro foot:

- aluminium powder coated
- polished aluminium

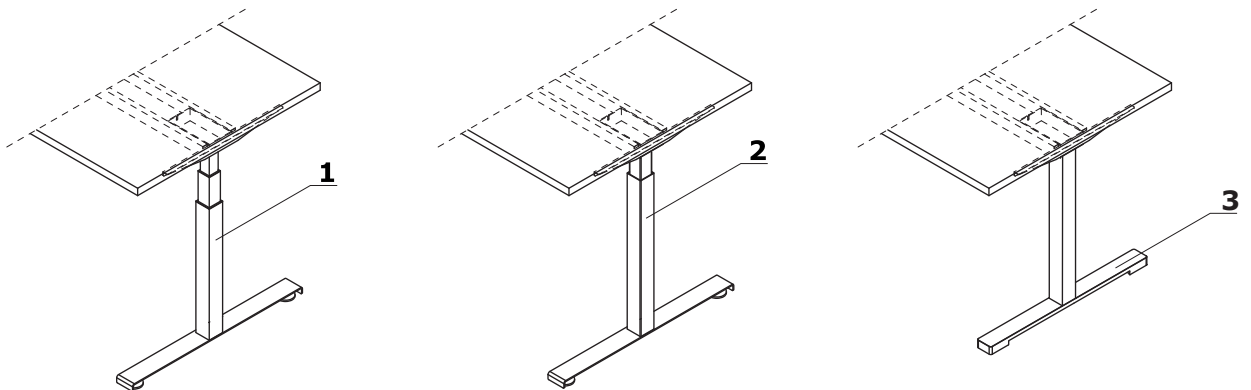

## Electric height adjustable frame - Ogi Drive

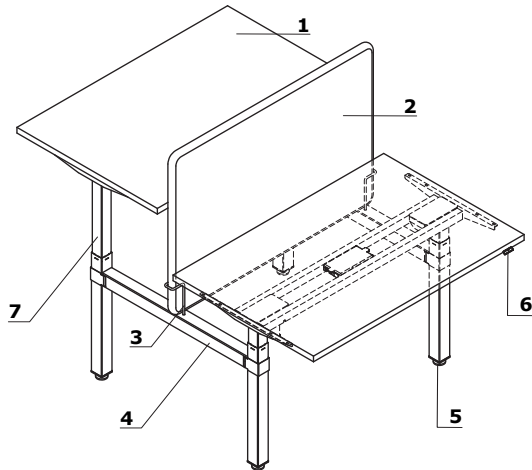

ATTENTION - distance between bench worktops 90 mm

1. **Worktop** - MFC 28 mm, ABS edge
2. **ZD Panel** - acoustic class A, zip fastener, pinable
3. **Fixing element** - powder coated metal
4. **Metal element for legs connecting**
5. **Leveling feet** - range 5 mm
6. **Control panel** - stepless height adjustment:
  - A - basic control panel; the sensitivity of the anti-collision system is set to Medium
  - B - OPTION WITH EXTRA CHARGE - up and down keypad with memory; the ability to change the sensitivity of the anti-collision system within 3 levels: Low, Medium, High
  - C - OPTION WITH EXTRA CHARGE - round control panel with memory; the ability to change the sensitivity of the anti-collision system within 3 levels: Low, Medium, High; mounted to the worktop
  - D - OPTION FOR AN ADDITIONAL COST - bluetooth module:
    - \* compatible with both panel A and B
    - \* the ability to change the sensitivity of the anti-collision system within 3 levels: Low, Medium, High
    - \* control via MDD Desk BT application (downloadable from Google Play or App Store). The app has a time interval function that informs the user about the need of changing body position (from sitting to standing or standing to sitting)
7. **Electric height adjustable frame** - powder coated steel, load 100 kg, telescopic leg

A

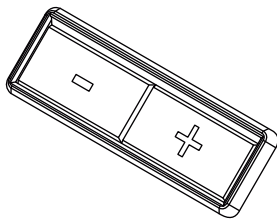

B

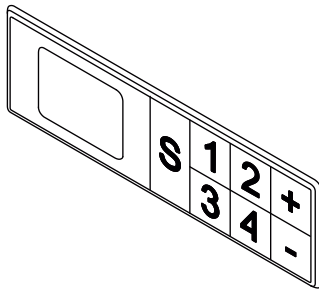

C

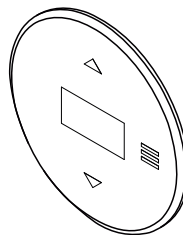

D

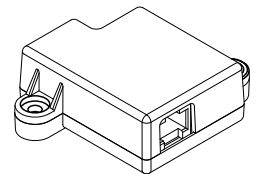

## Frame technical specification

- **Height adjustment** - 40 mm/sec Super Soft Start - Stop
- **Drive** - 2 synchronised motors with microprocessor, work control sensor
- **Noise level** - < 48dB
- **Anti collision mechanism**
- **Standards** - EN 527-2
- **EU Directives** - 206/95EC, UI508 1999, UL 1004 R7 06, WE DC 2004/108WE Stand - by mode 0.3 W
- **Power supply** - 230V, 256W

Ogi Drive	Date of preparation 02.11.2022	The data contained in this document is valid in the day of its preparation. Change of the product, as long as it does not affect the basic features of it, does not require consistent updates of the document.	page 4/13 technical description
-----------	-----------------------------------	---	------------------------------------

## Electric frame with common cable tray - Ogi Drive

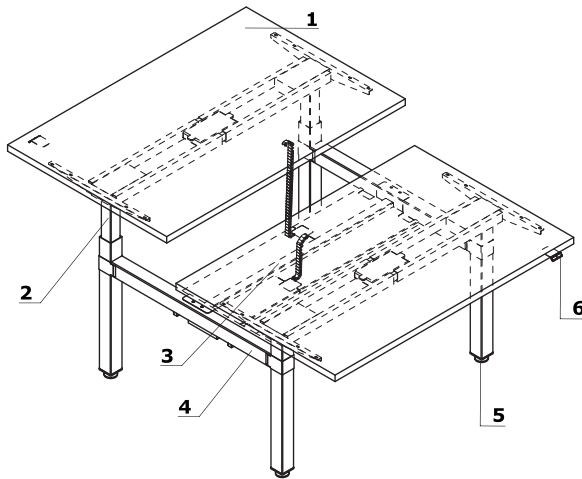

1. **Worktop** - MFC 28 mm, ABS edge
2. **Electric height adjustable frame** - powder coated steel, load 100 kg, telescopic leg
3. **Common cable tray + vertical cable organizer**
4. **Metal element for legs connecting**
5. **Leveling feet** - range 5 mm
6. **Control panel** - stepless height adjustment:
  - A - basic control panel; the sensitivity of the anti-collision system is set to Medium
  - B - OPTION WITH EXTRA CHARGE - up and down keypad with memory; the ability to change the sensitivity of the anti-collision system within 3 levels: Low, Medium, High
  - C - OPTION WITH EXTRA CHARGE - round control panel with memory; the ability to change the sensitivity of the anti-collision system within 3 levels: Low, Medium, High; mounted to the worktop
  - D - OPTION FOR AN ADDITIONAL COST - bluetooth module - compatible with control panel A and B - control via MDD Desk BT application (downloadable from Google Play or App Store). The app has a time interval function that informs the user about the need of changing body position (from sitting to standing or standing to sitting)

## Mediabox location

- A - left mediabox
- B - left/right mediabox
- C - right mediabox

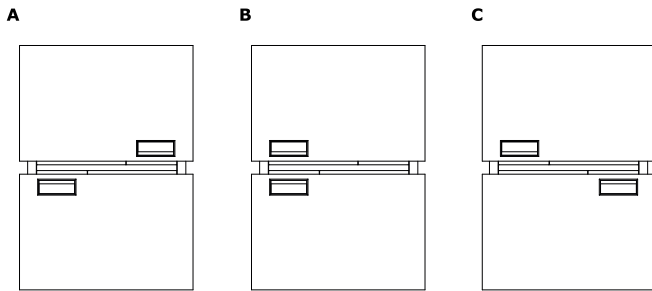

## Accessories

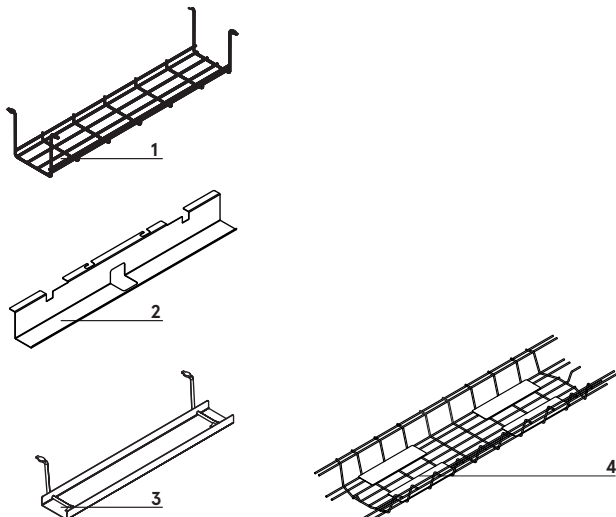

1. **Horizontal cable tray S69** - powder coated, colour: 09 - aluminum
2. **Single desk horizontal cable tray (SG12, SG16)** - powder coated metal, colour: M009 - aluminum semi-matt
3. **Horizontal cable tray E64** - powder coated, colour: M009 - aluminium semi-matt
4. **Cable tray for bench desks Ogi Drive (SOD12, SOD14, SOD16, SOD18, SOD20)** - powder coated, colour: M009 - aluminium semi-matt

Ogi Drive handle - dimensions (mm)

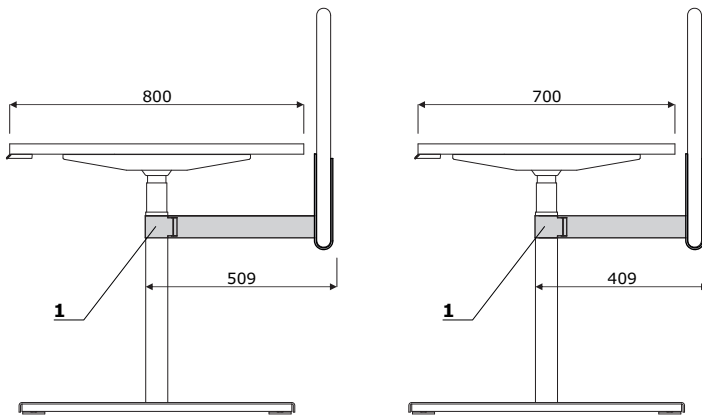

- 1. Ogi Drive screen bracket - an option with extra charge; mountable to the frame; powder-coated metal, 60x60mm profile

Caution - Ogi Drive screen bracket does not allow for pairing with screens equipped with accessories rail.

Power strip - for series connection

- 1. PWS1 - set for 1 workstation - power strip (3x SCHUCKO, 2x RJ45) x1 + power cord (universal outlet PL/FR/Schucko)
- 2. PWS2 - set for 2 workstation - power strip (3x SCHUCKO, 2x RJ45) x2 + set of power cords (universal outlet PL/FR/Schucko)
- 3. PWS3 - set for 3 workstation - power strip (3x SCHUCKO, 2x RJ45) x3 + set of power cords (universal outlet PL/FR/Schucko)

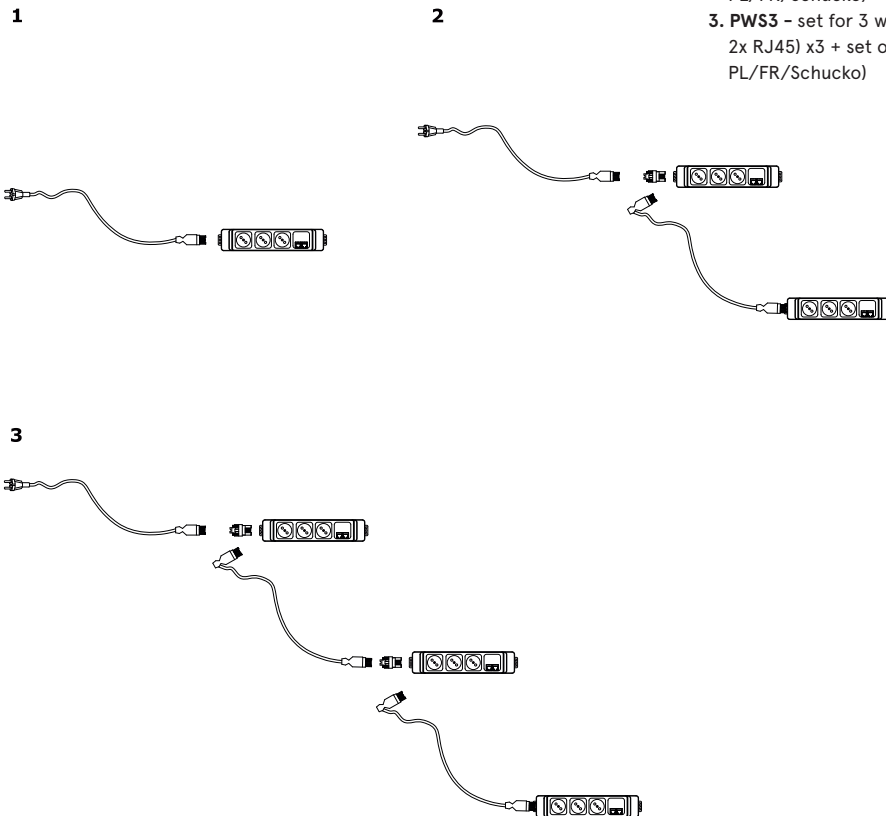

Simple desks electric height adjustment in the range of 700-1200 mm - sit-stand \*



**BOD527**  
1200 / 700 / 700-1200  
44.15 kg

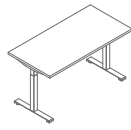

**BOD547**  
1400 / 700 / 700-1200  
48.2 kg

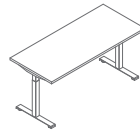

**BOD567**  
1600 / 700 / 700-1200  
52.55 kg

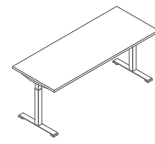

**BOD587**  
1800 / 700 / 700-1200  
54.05 kg

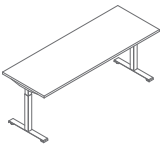

**BOD607**  
2000 / 700 / 700-1200  
54.3 kg



**BOD52**  
1200 / 800 / 700-1200  
47.75 kg

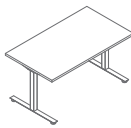

**BOD54**  
1400 / 800 / 700-1200  
50.65 kg

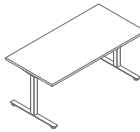

**BOD56**  
1600 / 800 / 700-1200  
55.5 kg

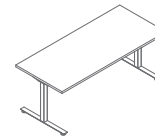

**BOD58**  
1800 / 800 / 700-1200  
58.45 kg

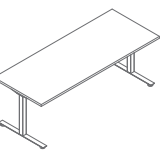

**BOD60**  
2000 / 800 / 700-1200  
62.25 kg

\* dimensions expressed in millimeters: width x depth x height

Single desks with electric height adjustment in the range of 650-1300 mm - sit-stand \*



**BOD627**  
1200 / 700 / 650-1300  
46.68 kg



**BOD647**  
1400 / 700 / 650-1300  
50.73 kg

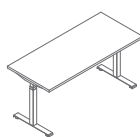

**BOD667**  
1600 / 700 / 650-1300  
55.08 kg

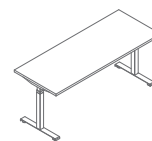

**BOD687**  
1800 / 700 / 650-1300  
56.58 kg

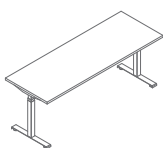

**BOD707**  
2000 / 700 / 650-1300  
56.83 kg

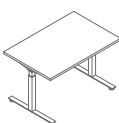

**BOD62**  
1200 / 800 / 650-1300  
50.28 kg

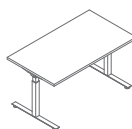

**BOD64**  
1400 / 800 / 650-1300  
53.18 kg

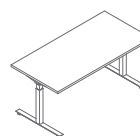

**BOD66**  
1600 / 800 / 650-1300  
58.03 kg

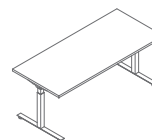

**BOD68**  
1800 / 800 / 650-1300  
60.98 kg

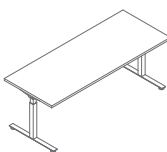

**BOD70**  
2000 / 800 / 650-1300  
64.78 kg

\* dimensions expressed in millimeters: width x depth x height



Bench desks with electric height adjustment in the range of 700-1200 mm – sit-stand \*

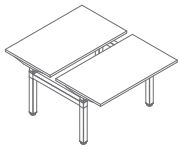

**BOD572**  
1200 / 1490 / 700-1200  
87,3 kg

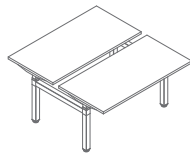

**BOD574**  
1400 / 1490 / 700-1200  
94,4 kg

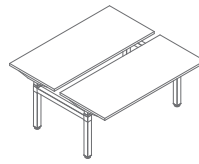

**BOD576**  
1600 / 1490 / 700-1200  
102,1 kg

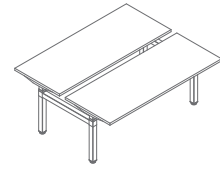

**BOD578**  
1800 / 1490 / 700-1200  
104,1 kg

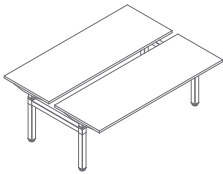

**BOD570**  
2000 / 1490 / 700-1200  
103,6 kg

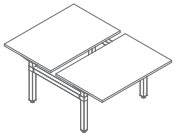

**BOD512**  
1200 / 1690 / 700-1200  
95 kg

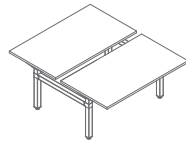

**BOD514**  
1400 / 1690 / 700-1200  
99,8 kg

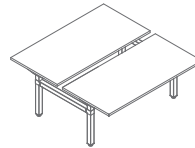

**BOD516**  
1600 / 1690 / 700-1200  
108,5 kg

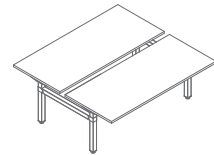

**BOD518**  
1800 / 1690 / 700-1200  
113,4 kg

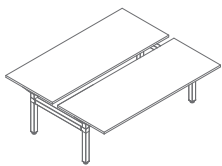

**BOD520**  
2000 / 1690 / 700-1200  
120 kg

\* dimensions expressed in millimeters: width x depth x height

Bench desks with electric height adjustment in the range of 650-1300 mm - sit-stand \*

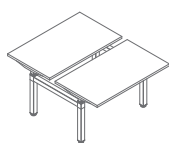

**BOD672**  
1200 / 1490 / 650-1300  
92.36 kg

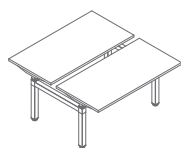

**BOD674**  
1400 / 1490 / 650-1300  
99.46 kg

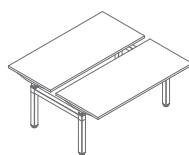

**BOD676**  
1600 / 1490 / 650-1300  
107.16 kg

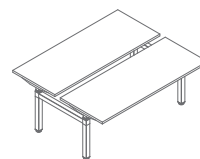

**BOD678**  
1800 / 1490 / 650-1300  
109.16 kg

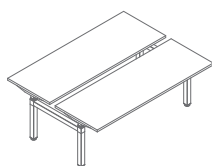

**BOD670**  
2000 / 1490 / 650-1300  
108.66 kg

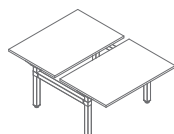

**BOD612**  
1200 / 1690 / 650-1300  
95.86100.06

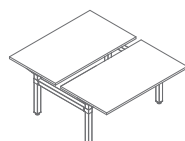

**BOD614**  
1400 / 1690 / 650-1300  
104.86 kg

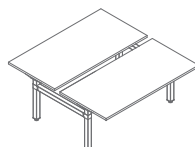

**BOD616**  
1600 / 1690 / 650-1300  
113.56 kg

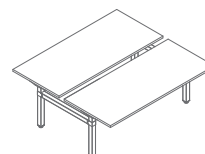

**BOD618**  
1800 / 1690 / 650-1300  
118.46 kg

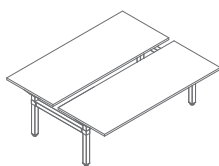

**BOD620**  
2000 / 1690 / 650-1300  
125.06 kg

\* dimensions expressed in millimeters: width x depth x height

Bench desks with common cable tray \*

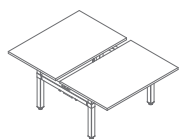

**BOD712**  
1200 / 1690 / 700-1200  
102 kg

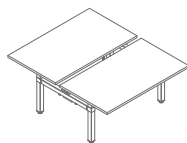

**BOD714**  
1400 / 1690 / 700-1200  
108,3 kg

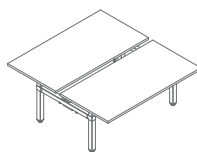

**BOD716**  
1600 / 1690 / 700-1200  
118,5 kg

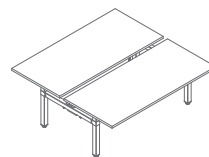

**BOD718**  
1800 / 1690 / 700-1200  
124,4 kg

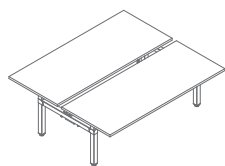

**BOD720**  
2000 / 1690 / 700-1200  
133 kg

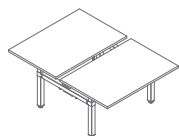

**BOD812**  
1200 / 1690 / 650-1300  
107,06 kg

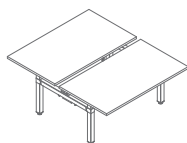

**BOD814**  
1400 / 1690 / 650-1300  
113,36 kg

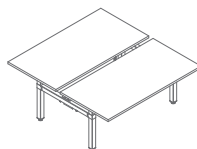

**BOD816**  
1600 / 1690 / 650-1300  
123,56 kg

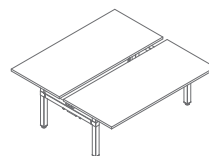

**BOD818**  
1800 / 1690 / 650-1300  
129,46 kg

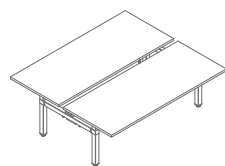

**BOD820**  
2000 / 1690 / 650-1300  
104,6 kg

\* dimensions expressed in millimeters: width x depth x height

One leg desk electric height adjustment in the range of 650-1300 mm - sit-stand \*

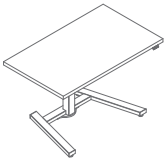

**BOD100**  
1000 / 600 / 650-1300  
25 kg

Sonic - acoustic screens for bench desks \*

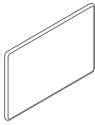

**ZD812**  
1190 / 40 / 800  
6.1 kg

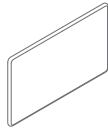

**ZD814**  
1390 / 40 / 800  
8.6 kg

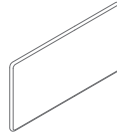

**ZD816**  
1590 / 40 / 800  
7.9 kg

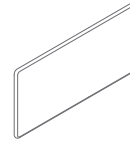

**ZD818**  
1790 / 40 / 800  
8.9 kg

www.mdd.eu

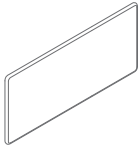

**ZD820**  
1990 / 40 / 800  
9.3 kg

Power strip



**PWS1**  
500 / 430 / 569  
1.1 kg



**PWS2**  
500 / 430 / 569  
1.6 kg

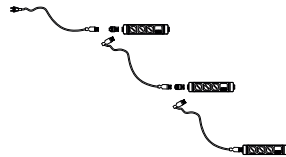

**PWS3**  
500 / 430 / 569  
2.1 kg

\* dimensions expressed in millimeters: width x depth x height

Ogi Drive	Date of preparation 02.11.2022	The data contained in this document is valid in the day of its preparation. Change of the product, as long as it does not affect the basic features of it, does not require consistent updates of the document.	page 12/13
			products

## Worktop



## Frame - metal



## Mediabox - metal



## Grommets



## Foot Pro



\* body - II group

\*\* additional charge option: one-time charge for the colour (200 €) + 10% of the product value

\*\*\* OPTION WITH EXTRA CHARGE

Ogi Drive	Date of preparation 02.11.2022	The data contained in this document is valid in the day of its preparation. Change of the product, as long as it does not affect the basic features of it, does not require consistent updates of the document.	page 13/13
			colours